

Article number: 2011301250ST
 Description: E+G Lifting pins in Steel,
 GN 1130-12-50-ST

Measures

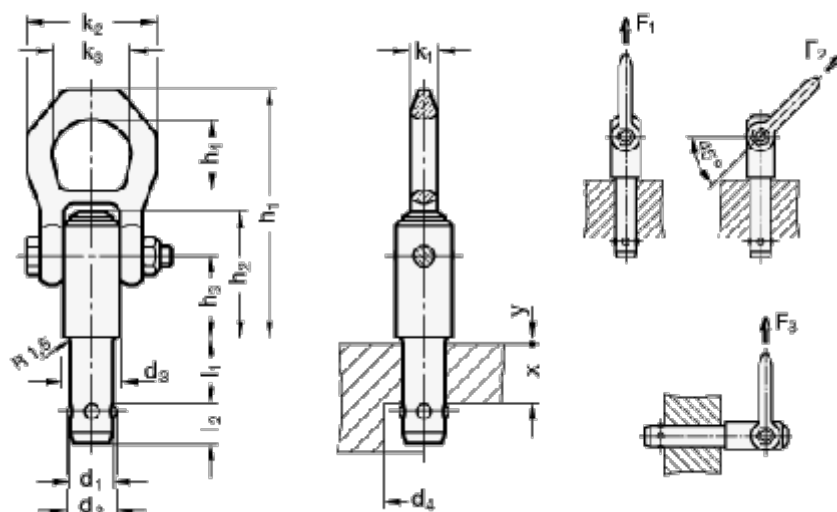

d1	= 12	h4	= 27	y = 1.5
d2	= 14.2	l1	= 50	
d3	= 21.5	l2	= 11	
d4	= 14.7	k1	= 11	
F1/F2/F3 load in kN	= 3,5/3,2/2,8	k2	= 49	
h1	= 87.5	k3	= 30	
h2	= 38.5	Weight (g)	= 267	
h3	= 25.7	x	= 35	